

PTA 3101 Floor stand for TabLock

Article number (SKU) 7493110
Colour Black

Key Benefits

- Theft prevention
- Easy to install
- Stylish design

PTA 3101 is a floorstand designed to be used in combination with the Vogel's PTS secure tablet enclosures.

The PTS tablet enclosure is secured to the floorstand with screws inside the tablet enclosure. The stand consists of a stylish aluminium pole with an integrated cable management system and a stable steel baseplate. The tilt angle is adjustable between 0-90 degrees.

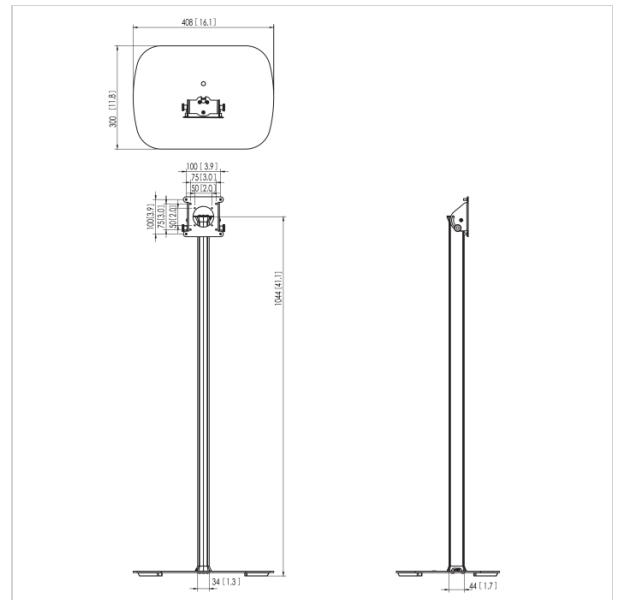
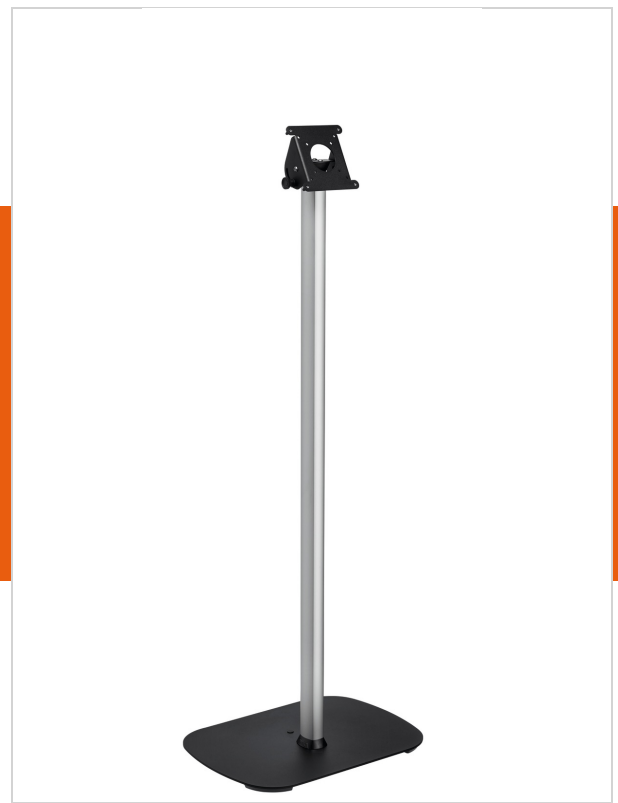

PTA 3101 Floor stand for TabLock



VOGEL'S HOLDING BV 2018 (c) All rights reserved
Subject to printing errors, technical and price
amendments
Date: 10-05-2018

www.vogels.com

Specifications

Product specifications

Product type number	PTA 3101
Article number (SKU)	7493110
Colour	Black
EAN single box	8712285334726
Tilt	Tilt up to 90°
Guarantee	5 years
Max. weight load (kg)	3
Min. hole pattern	50mm x 50mm
Max. hole pattern	100mm x 100mm

Features

Functionality	Tilt
Professional features	

Max. height mid display (mm)	1000
Height (mm)	1000
Height of trolley/stand (mm)	1000

