



For Sure



# Podlahový TV stojan TVS 3690 & TVS 3695

Představení produktu





## Představujeme nejnovější Vogel's TV stojany: TVS 3690/3695

---



**TVS 3690** black



**TVS 3695** black



**TVS 3695** white





## Představujeme nejnovější Vogel's TV stojany: TVS 3690/3695

---

Flexibilní způsob umístění vaší TV, který je zároveň vstřícný k životnímu prostředí. Navržen, zkonstruován a vyroben tak, aby vyhovoval požadavkům současného trhu s TV:

- pro velké TV - až do úhlopříčky 77"/195 cm
- a pro velkou zátěž - až do 50kg





## TVS 3690/3695, flexibilní řešení

---

- Hledáte svobodný způsob umístění vaší TV na libovolné místo u vás doma? Použijte podlahový TV stojan Vogel's!
- Otáčení o 90° vám umožní sledovat TV z jakéhokoliv místa v pokoji.
- Stojan má integrované nastavení výšky, takže ji můžete upravit i bez demontáže TV přesně podle vaší potřeby.





## TVS 3695, udržitelné řešení

---

- Vogel's si cení produktů, které jsou vyrobeny s respektem vůči lidem a životnímu prostředí.
- Těmto hodnotám plně odpovídají i high-end materiály a PEFC-certifikovaný prémiový francouzský dub, hlavní komponenty stojanu TVS 3695.
  - PEFC™ je celosvětová nezávislá značka pro podporu udržitelného lesního hospodaření.



## TVS 3690/3695, navržen s ohledem na zákazníka

---

- Regulátor horizontální roviny umožní TV perfektně vyrovnat
- Díky chytré integraci vedení kabelů nohou stojanu jsou zamotané kabely minulostí
- Volitelný držák SOUND 3550 pomůže stylově zavěsit váš soundbar pod TV





## TVS 3690/3695, For Sure

---

- U Vogel's je bezpečnost na prvním místě! Každý výrobek Vogel's je testován podle nejvyšších standardů co se týče bezpečnosti, spolehlivosti a odolnosti.
- TVS 3690/3695 je testován a schválen dle TÜV bezpečnostních standardů.
- Maximální možné zatížení TVS 3690/3695 je testováno na 3x vyšší zátěž než je maximální doporučená.







## Hlavní charakteristiky TVS 3690

Navržen pro  
TV do 77" a  
max. 50kg

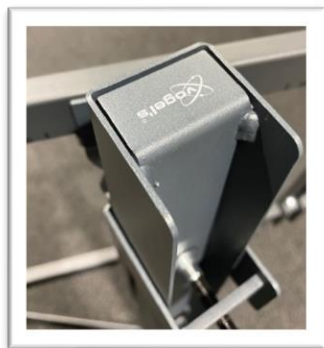

Snadno otáčeš TV  
až o 90° díky  
OneFinger  
Movement™



Snadno nastavitelná výška i  
při namontované TV



Šikově ved' kably  
vnitřkem  
stojanu



## Hlavní charakteristiky TVS 3695

Navržen pro  
TV do 77" a  
max. 50kg

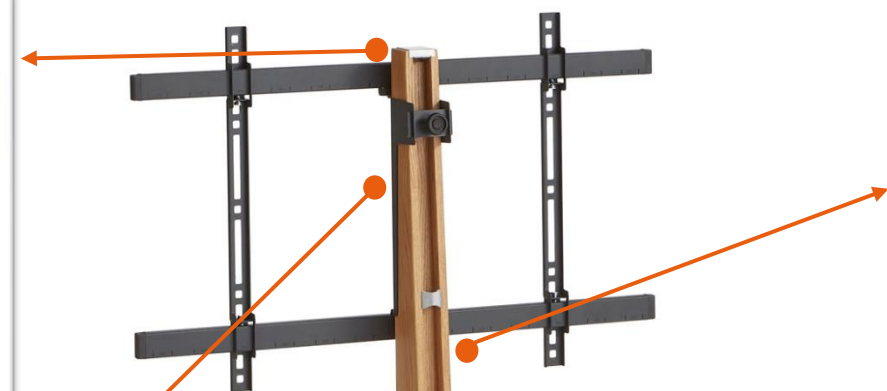

Snadno otáčej TV  
až o 90° díky  
OneFinger  
Movement™

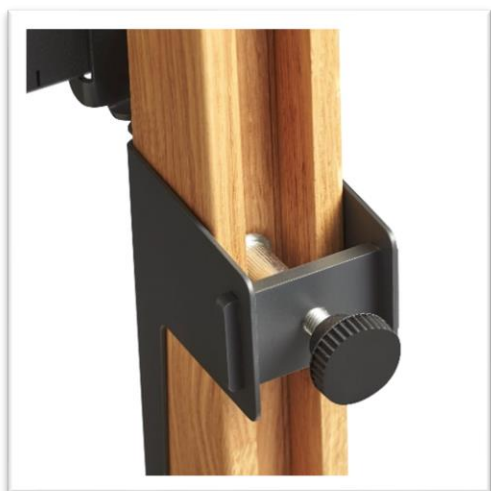

Snadno nastavitelná výška i  
při namontované TV

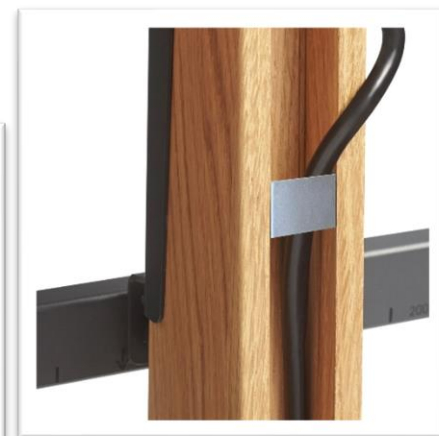

Šikavně ved' kabley  
vnitřkem  
stojanu

## Competitive Landscape – Specification Comparison



	Vogel's Stand	OFA Tripod	Samsung Stand	BARB	CAVUS Cross
Up to 77" & 600x400	✓	✗	✗	✗	✗
Up to 50kg	✓	✗	✗	?	✗
Up to 90° rotatable	✓	✓	✗	✗	✓
Height adjustment	✓	✗	✗	✗	✓
Cable management	✓	✓	✓	✓	✓
Horizontal leveling	✓	✗	✗	✗	?
Option to mount soundbar	✓	✓	✓	✓	✓
TüV-certified	✓	✗	✗	✗	✗



## Product photography – product images

---







## Product photography – detail images

---



## Product photography – USP images







## Už téměř 50 let na špičce

Víte co Vogel's nabízí. Design, pohodlí, inovaci, spolehlivost a snadnou instalaci. Jak jednotlivě tak v souhrnu jde o znaky kvality, kterými se Vogel's vyznačuje. Už téměř po 50 let. Vogel's neposkytuje pouhé montážní řešení. Dostáváte jistotu nejlepšího řešení. **For sure.**

# Příloha

Rozměry  
Logistické informace  
Srovnání TVS s NEXT OP

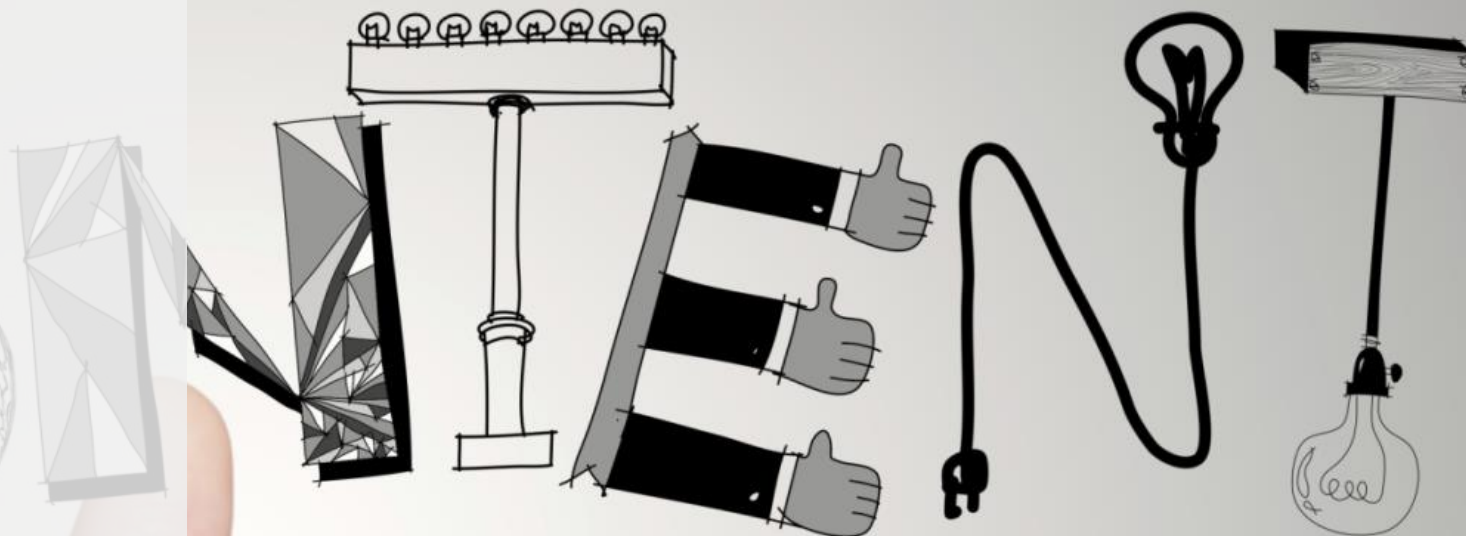



## Rozměry

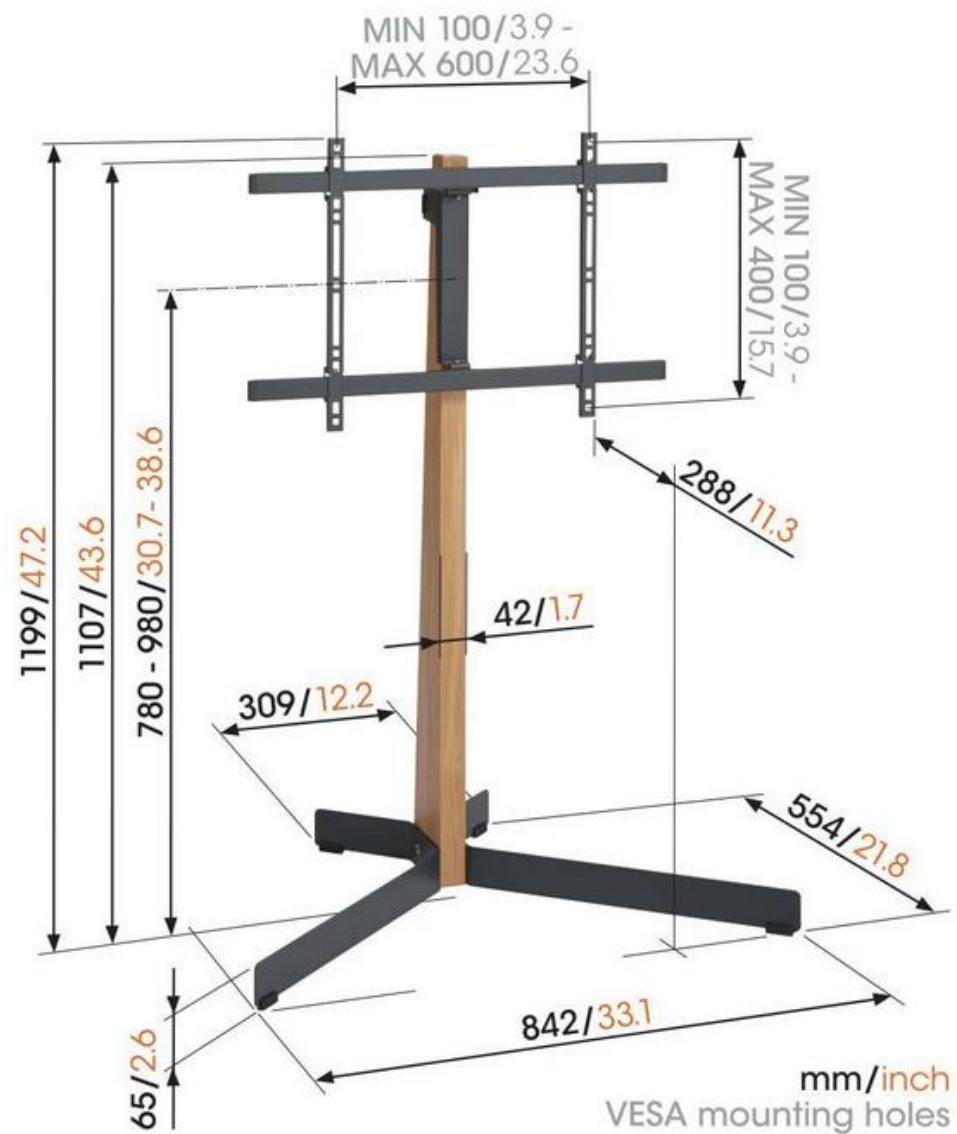

Číslo modelu	Typové označení	Obchodní popis	Barva	Záruka	Rozměry obchodního balení	Hmotnost brutto	EAN obchodní balení	Počet na paletě
					D x Š x V [mm]	[kg]	EAN-13	
3836900	TVS 3690	TVS 3690 PODLAHOVÝ TV STOJAN	Černý	10 let	1173 x 325/65 x 74	12.8	8712285355189	80
3836950	TVS 3695	TVS 3695 PODLAHOVÝ TV STOJAN	Černý	10 let	1173 x 325/65 x 74	11.5	8712285353345	80
3836951	TVS 3695	TVS 3695 PODLAHOVÝ TV STOJAN	Bílý	10 let	1173 x 325/65 x 74	11.5	8712285353369	80



## TVS 3695 TV Floor Stand

Designed in the Netherlands

Made in the EU



MODEL NO. 3836950  
OAK & STEEL



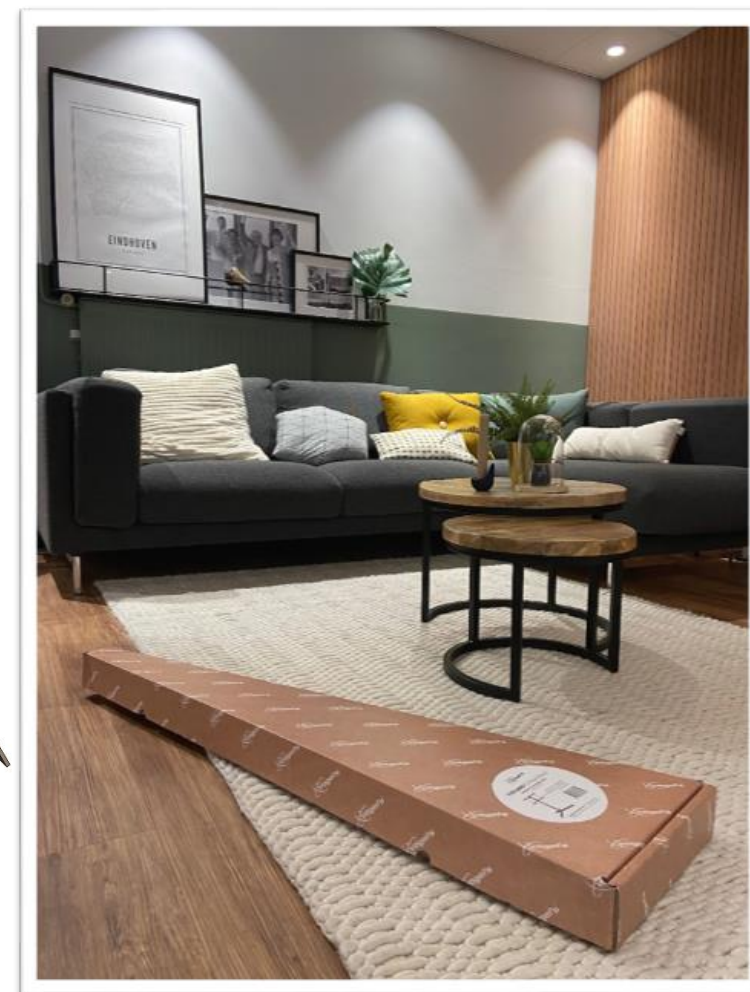
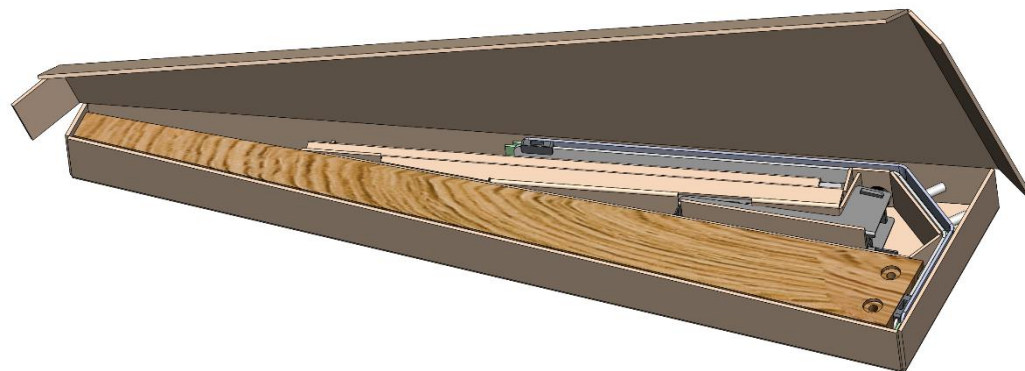

8 712285 353345 >

Vogel's Products BV  
Hondsruglaan 93 5628 DB  
Eindhoven, The Netherlands



## TVS 3695 vs NEXT OP1 & OP2

	TVS 3690/3695	OP1	OP2
			
Max úhlopříčka	77"	70"	77"
Max VESA	600 x 400 mm	400 x 400 mm	400 x 400 mm
Max zatížení	50 kg	40 kg	50 kg
Otáčení	2x 45°	-	-
Úprava roviny		-	-
Volitelný držák soundbaru	SOUND 3550	-	OPSOUND
Stylové řešení uchycení příslušenství	-	OPHANG	OPHANG
Skandinávský design(100% dub)	-	✓	✓
Ocenění	-	Good Industrial Design Award	-



For Sure